

Data sheet | Item number: 750-537

8-channel digital output; 24 VDC; 0.5 A; Diagnostics

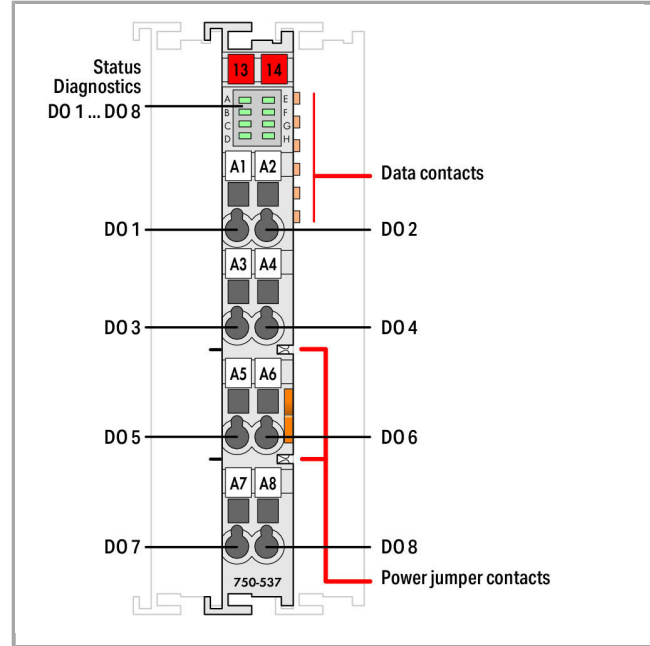

750-537

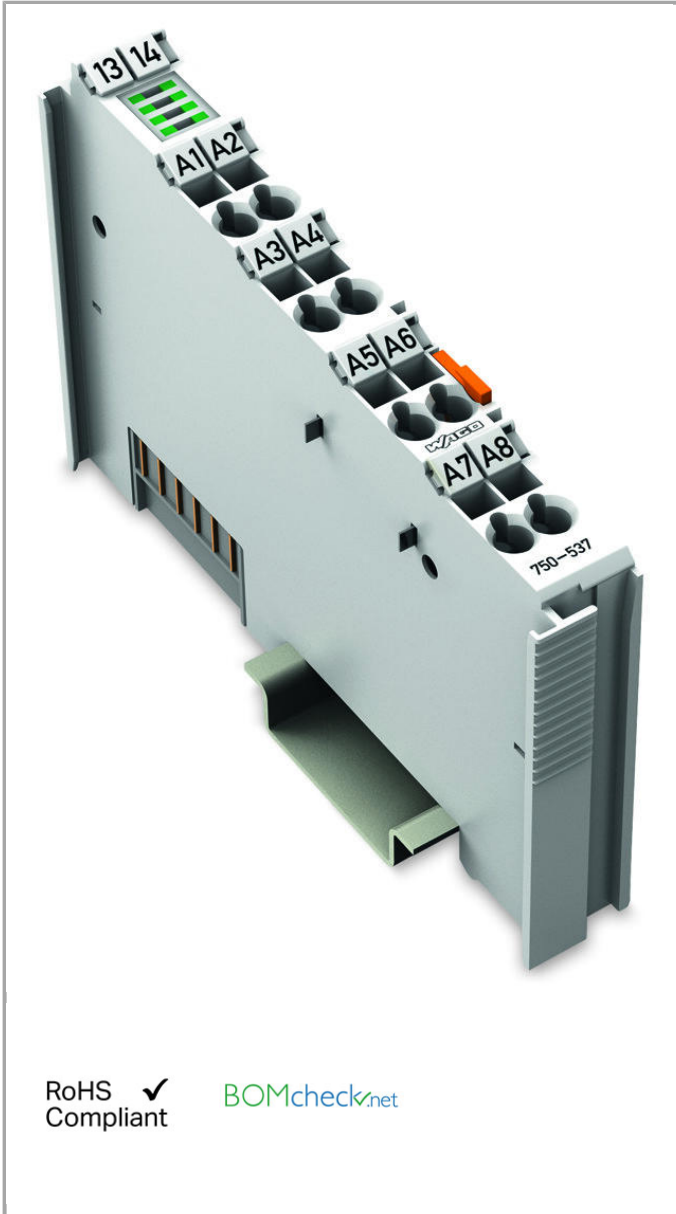

RoHS  Compliant

[BOMcheck.net](https://www.bomcheck.net)

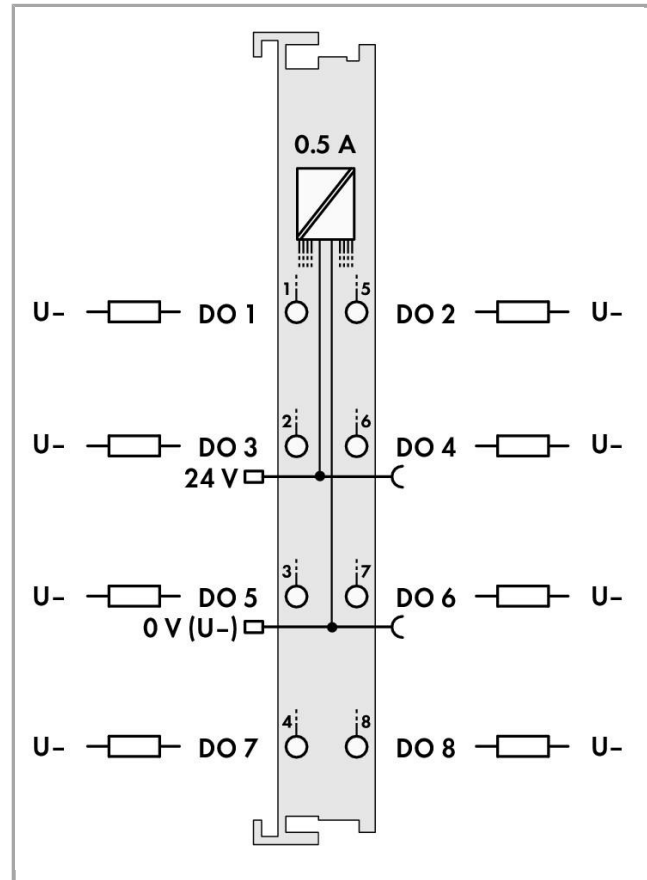
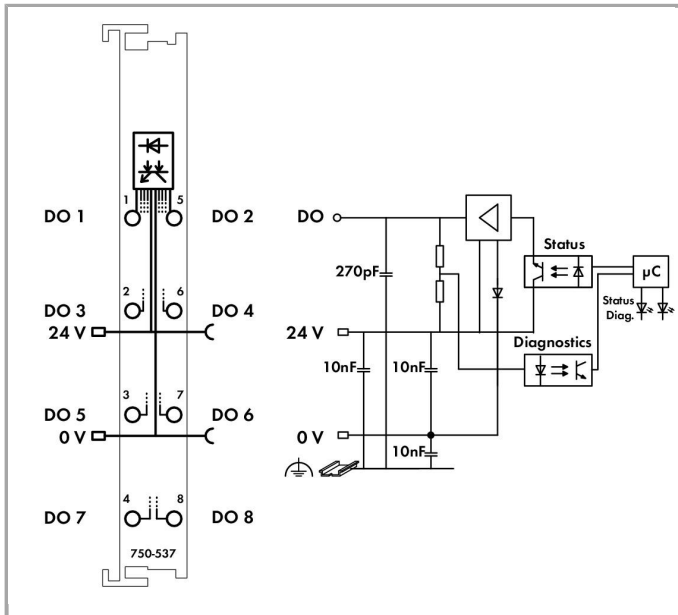

## Item description

This digital output module transmits control signals from the automation device to the connected actuators.

All outputs are short-circuit-protected.

This output module detects the following errors: overload, short circuit and wire break.

The status is transmitted to the fieldbus coupler and indicated by LEDs.

The module is an 8-channel device and eight actuators may be connected to it.

Field and system levels are electrically isolated.

## Data

### Technical Data

Number of digital outputs	8
Total number of channels (module)	8
Type of signal	Voltage
Actuator connection	8 x (1-conductor)
Output characteristic	high-side switching
Output current per channel	0.5 A



Output current	short-circuit-protected
Switching frequency max.	1 kHz
Type of load	resistive, inductive, lamps
Diagnostics	Open circuit, overload and short circuit
Reverse voltage protection	yes
Open-circuit detection	0.1 mA
Short-circuit limitation typ. Pwm	12 A
Switching frequency max.	1000 Hz
Inductive load switch-off energy dissipation W (max.)	0.1 J
Max input data width (internal)	8 Bit
Max output data width (internal)	8 Bit
System supply voltage	DC 5 V; via data contacts
Current consumption, system supply (5 V)	50 mA
System and sensor supply voltage	)
Field supply voltage	DC 24 V (-25 ... +30 %); über Leistungskontakte (Einspeisung über Messerkontakt; Weiterleitung über Federkontakt)
Current consumption, field supply (module with no external load)	16 mA
Isolation field – system	500 VAC (1 min)
Indicators	LED (A-H) green: Status DO 1 ... DO 8; LED (A-H) red: Diagnostics DO 1 ... DO 8
Number of incoming power jumper contacts	2
Number of outgoing power jumper contacts	2
Current carrying capacity of the power jumper contacts	10 A

### Connection data

Connection technology: In-/Outputs	8 x CAGE CLAMP®
Connection type (1)	Inputs/Outputs
Solid conductor	0.08 ... 2.5 mm <sup>2</sup> / 28 ... 14 AWG
Fine-stranded conductor	0.08 ... 2.5 mm <sup>2</sup> / 28 ... 14 AWG
Strip length	8 ... 9 mm / 0.31 ... 0.35 inch

### Geometrical Data

Width	12 mm / 0.472 inch
Height	67.8 mm / 2.669 inch
Height from upper-edge of DIN-35 rail	60.6 mm / 2.386 inch
Depth	100 mm / 3.937 inch

### Mechanical data

Type of mounting	DIN-35 rail
------------------	-------------

## Material Data

Color	light gray
Housing material	Polycarbonate, polyamide 6.6
Weight	50.964 g
Conformity marking	1

## Environmental Requirements

Surrounding air (operating) temperature	0 ... 55 °C
Surrounding air (storage) temperature	-40 ... 85 °C
Protection class	IP20
Degree of pollution (5)	2 per IEC 61131-2
Operating altitude	0 ... 2000 m
Mounting position	horizontal (standing/lying) or vertical
Relative air humidity (no condensation)	95 %
Vibration resistance	4g per IEC 60068-2-6
Shock resistance	15g per IEC 60068-2-27
EMC immunity to interference	acc. to EN 61000-6-2, marine applications
EMC emission of interference	acc. to EN 61000-6-3, marine applications
Exposure to pollutants	Per IEC 60068-2-42 and IEC 60068-2-43
Permissible H <sub>2</sub> S contaminant concentration at a relative humidity 75 %	10 ppm
Permissible SO <sub>2</sub> contaminant concentration at a relative humidity 75 %	25 ppm

## Commercial data

Product Group	15 (Remote I/O)
Country of origin	DE
GTIN	4045454431853
Customs Tariff No.	85371098990















## Approvals / Certificates



















### Ship Approvals

Logo	Approval	Additional Approval Text	Certificate name
	<b>ABS</b> American Bureau of Shipping	Rules for class. of Steel Ships	16- HG1554285- PDA







## Compatible products

## system box









	<b>Item no.: 850-804</b> IP65 enclosure; Stainless steel; WxHxD (400x123x200 mm); 4 x M20, 16 x M16, 28 x M12 cable grip	850-804
	<b>Item no.: 850-804/000-001</b> IP65 enclosure; Stainless steel; WxHxD (400x123x200 mm); 2 x M20, 13 x M16, 32 x M12 cable grip	850-804
	<b>Item no.: 850-805</b> IP65 enclosure; Stainless steel; WxHxD (600x123x200 mm); 4 x M20, 19 x M16, 67 x M12 cable grip	850-805
	<b>Item no.: 850-814/002-000</b> IP65 enclosure; Sheet steel (RAL 7035); WxHxD (200x120x200 mm); without flange plate	850-814
	<b>Item no.: 850-815/002-000</b> IP65 enclosure; Sheet steel (RAL 7035); WxHxD (300x120x200 mm); without flange plate	850-815
	<b>Item no.: 850-816/002-000</b> IP65 enclosure; Sheet steel (RAL 7035); WxHxD (400x120x200 mm); without flange plate	850-816
	<b>Item no.: 850-817/002-000</b> IP65 enclosure; Sheet steel (RAL 7035); WxHxD (600x120x200 mm); without flange plate	850-817
	<b>Item no.: 850-825</b> IP65 enclosure; Aluminium (RAL 7032); WxHxD (160x100x160 mm); 9 x M12, 4 x M20	850-825
	<b>Item no.: 850-826</b> IP65 enclosure; Aluminium (RAL 7032); WxHxD (240x100x160 mm); 4 x M20, 4 x M16, 14 x M12 cable grip	850-826
	<b>Item no.: 850-826/002-000</b> IP65 enclosure; Aluminium (RAL 7035); WxHxD (240x100x160 mm); 4 x M20, 4 x M16, 14 x M12 cable grip	850-826
	<b>Item no.: 850-827</b> IP65 enclosure; Aluminium (RAL 7032); WxHxD (320x100x160 mm); 4 x M20, 8 x M16, 17 x M12 cable grip	850-827
	<b>Item no.: 850-827/002-000</b> IP65 enclosure; Aluminium (RAL 7035); WxHxD (320x100x160 mm); 4 x M20, 8 x M16, 17 x M12 cable grip	850-827
	<b>Item no.: 850-828</b> IP65 enclosure; Aluminium (RAL 7032); WxHxD (480x100x160 mm); 4 x M20, 10 x M16, 35 x M12 cable grip	850-828
	<b>Item no.: 850-828/002-000</b> IP65 enclosure; Aluminium (RAL 7035); WxHxD (480x100x160 mm); 4 x M20, 10 x M16, 35 x M12 cable grip	850-828











	<b>Item no.: 850-834</b> IP65 enclosure; Polyester (RAL 7032); WxHxD (164x100x164 mm); 9 x M12, 4 x M20	850-834
	<b>Item no.: 850-835</b> IP65 enclosure; Polyester (RAL 7032); WxHxD (244x100x164 mm); 4 x M20, 4 x M16, 14 x M12 cable grip	850-835
	<b>Item no.: 850-836</b> IP65 enclosure; Polyester (RAL 7032); WxHxD (324x100x164 mm); 4 x M20, 8 x M16, 17 x M12 cable grip	850-836
<b>Supply module</b>		
	<b>Item no.: 750-601</b> Power Supply; 24 VDC	750-601
	<b>Item no.: 750-602</b> Power Supply; 24 VDC	750-602
	<b>Item no.: 750-610</b> Power Supply; 24 VDC; fuse holder; Diagnostics	750-610
	<b>Item no.: 750-612</b> Power Supply; 0 ... 230 V AC/DC	750-612
<b>Carrier rail</b>		
	<b>Item no.: 210-112</b> Steel carrier rail; 35 x 7.5 mm; 1 mm thick; 2 m long; slotted; according to EN 60715; "Hole width 25 mm	210-112
	<b>Item no.: 210-113</b> Steel carrier rail; 35 x 7.5 mm; 1 mm thick; 2 m long; unslotted; according to EN 60715	210-113
	<b>Item no.: 210-114</b> Steel carrier rail; 35 x 15 mm; 1.5 mm thick; 2 m long; unslotted; similar to EN 60715	210-114
	<b>Item no.: 210-115</b> Steel carrier rail; 35 x 7.5 mm; 1 mm thick; 2 m long; slotted; according to EN 60715; "Hole width 18 mm	210-115
	<b>Item no.: 210-118</b> Steel carrier rail; 35 x 15 mm; 2.3 mm thick; 2 m long; unslotted; according to EN 60715	210-118
	<b>Item no.: 210-196</b> Aluminum carrier rail; 35 x 8.2 mm; 1.6 mm thick; 2 m long; unslotted; similar to EN 60715	210-196
	<b>Item no.: 210-197</b> Steel carrier rail; 35 x 15 mm; 1.5 mm thick; 2 m long; slotted; similar to EN 60715	210-197
	<b>Item no.: 210-198</b> Copper carrier rail; 35 x 15 mm; 2.3 mm thick; 2 m long; unslotted; according to EN 60715	210-198
	<b>Item no.: 210-504</b> Steel carrier rail; 35 x 7.5 mm; 1 mm thick; 2 m long; slotted; galvanized; according to EN 60715	210-504
	<b>Item no.: 210-505</b> Steel carrier rail; 35 x 7.5 mm; 1 mm thick; 2 m long; unslotted; galvanized; according to EN 60715	210-505
	<b>Item no.: 210-506</b> Steel carrier rail; 35 x 15 mm; 1.5 mm thick; 2 m long; unslotted; galvanized; similar to EN 60715	210-506
	<b>Item no.: 210-508</b> Steel carrier rail; 35 x 15 mm; 1.5 mm thick; 2 m long; slotted; galvanized; similar to EN 60715	210-508

## shield connection

	<b>Item no.: 790-108</b> Shield clamping saddle; 11 mm wide; diameter of compatible conductor	790-108
	<b>Item no.: 790-116</b> Shield clamping saddle; 19 mm wide; diameter of compatible conductor; 7 ... 16 mm	790-116
	<b>Item no.: 790-124</b> Shield clamping saddle; 27 mm wide; diameter of compatible conductor; 6 ... 24 mm	790-124
	<b>Item no.: 790-140</b> Shield clamping saddle; diameter of compatible conductor	790-140
	<b>Item no.: 790-208</b> Shield clamping saddle; 12.4 mm wide; 3 ... 8 mm	790-208
	<b>Item no.: 790-216</b> Shield clamping saddle; 21.8 mm wide; 6 ... 16 mm	790-216
	<b>Item no.: 790-220</b> Shield clamping saddle; 30 mm wide; 6 ... 20 mm	790-220

## Marking accessories

	<b>Item no.: 2009-145</b> Mini-WSB Inline; for Smart Printer; on reel; stretchable 5 - 5.2 mm; plain; snap-on type	2009-145
	<b>Item no.: 2009-145/000-002</b> Mini-WSB Inline; for Smart Printer; on reel; stretchable 5 - 5.2 mm; plain; snap-on type	2009-145 /000-002
	<b>Item no.: 2009-145/000-005</b> Mini-WSB Inline; for Smart Printer; on reel; stretchable 5 - 5.2 mm; plain; snap-on type	2009-145 /000-005
	<b>Item no.: 2009-145/000-006</b> Mini-WSB Inline; for Smart Printer; on reel; stretchable 5 - 5.2 mm; plain; snap-on type	2009-145 /000-006
	<b>Item no.: 2009-145/000-007</b> Mini-WSB Inline; for Smart Printer; on reel; stretchable 5 - 5.2 mm; plain; snap-on type	2009-145 /000-007
	<b>Item no.: 2009-145/000-012</b> Mini-WSB Inline; for Smart Printer; on reel; stretchable 5 - 5.2 mm; plain; snap-on type	2009-145 /000-012
	<b>Item no.: 2009-145/000-023</b> Mini-WSB Inline; for smartPRINTER; on reel; stretchable 5 - 5.2 mm; plain; snap-on type	2009-145 /000-023
	<b>Item no.: 2009-145/000-024</b> Mini-WSB Inline; for Smart Printer; on reel; stretchable 5 - 5.2 mm; plain; snap-on type	2009-145 /000-024
	<b>Item no.: 248-501</b> Miniature WSB Quick marking system; plain; Marker width 5 mm; 10 strips with 10 markers per card	248-501

	<b>Item no.: 248-501/000-002</b> Mini-WSB marking card; as card; not stretchable; plain; snap-on type	248-501	7000-002
	<b>Item no.: 248-501/000-005</b> Mini-WSB marking card; as card; not stretchable; plain; snap-on type	248-501	7000-005
	<b>Item no.: 248-501/000-006</b> Mini-WSB marking card; as card; not stretchable; plain; snap-on type	248-501	7000-006
	<b>Item no.: 248-501/000-007</b> Mini-WSB marking card; as card; not stretchable; plain; snap-on type	248-501	7000-007
	<b>Item no.: 248-501/000-012</b> Mini-WSB marking card; as card; not stretchable; plain; snap-on type	248-501	7000-012
	<b>Item no.: 248-501/000-017</b> Mini-WSB marking card; as card; not stretchable; plain; snap-on type	248-501	7000-017
	<b>Item no.: 248-501/000-023</b> Mini-WSB marking card; as card; not stretchable; plain; snap-on type	248-501	7000-023
	<b>Item no.: 248-501/000-024</b> Mini-WSB marking card; as card; not stretchable; plain; snap-on type	248-501	7000-024
	<b>Item no.: 750-103</b> Group marker carrier	750-103	
	<b>Item no.: 750-107</b> Group marker carrier	750-107	

## Downloads

### Documentation

#### Manual

8-channel, 24VDC, 0.5A short-circuit protected, high-side switching, diagnostics	V 1.1.0	pdf 2.0 MB	Download
---	---------	---------------	----------

#### Bid Text

750-537 IO-Klemmen	Oct 2, 2014	doc 29.7 kB	Download
-----------------------	-------------	----------------	----------

#### Additional Information

Disposal; Electrical and electronic equipment, Packaging	V 1.0.0	pdf 265.8 kB	Download
--	---------	-----------------	----------



## System Description

750/753 Series I/O-System – General Product Information		pdf 1.7 MB	Download
Use in Hazardous Environments Term definition, marking and installation regulations	V 1.0.0	pdf 1.0 MB	Download
Design Notes Basic conditions and recommendations for higher operational safety	V 2.0.0	pdf 1.5 MB	Download
Overview on WAGO-I/O-SYSTEM 750 approvals		pdf 780.2 kB	Download

## CAD/CAE - Smart Data

### CAD data

3D Download 750-537		URL	Download
---------------------	--	-----	----------

## Device Files

### Device Driver

WAGO USB Service Cable Driver / 750 and 857 Series 759-923	6.5.3.0 Sep 10, 2014	zip 4.8 MB	Download
---	-------------------------	---------------	----------

## Product family

**750/753 Series I/O-System**  
[Learn more about the product family.](#)

[Show all products from the family](#)

Subject to changes.